

TOTALSLIDE® PRO

Hardware Installation Guidelines

The following scenarios show detailed installation guidelines when installing the TotalSlide® Pro system components. In general, please keep in mind the following when installing TotalSlide Pro:

- TotalSlide Pro components are compatible with all TotalSlide Hardware
- The TotalSlide Pro Hang Rod Assembly is specifically designed to install on ClosetMaid 12" and 16" All-Purpose (SuperSlide/Linen) Shelving as well as Heavy Duty Shelving
- We suggest you install the Hang Rod Assembly on the shelf at the warehouse prior to transporting for installation (per instruction in TotalSlide Pro Installation Video)
- Please follow TotalSlide Pro Hang Rod Assembly handling instructions (located after the installation guidelines) when moving or transporting sections of the assembly



1

Installation Guidelines

Hang Rod Assembly/ Hang Stop Configuration

Open to Open Hang Rod Installation

Installation example - Hang Stops end a Hang Rod section in the middle of All-Purpose (Linen/SuperSlide) shelving:

Use Hang Stops to end a hanging section of Hang Rod Assembly on a shelf.

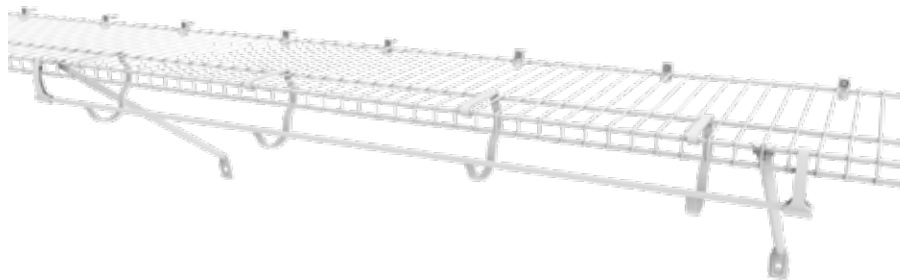

Closed to Closed Hang Rod Installation

Installation example - When Shelf Stops end a Hang Rod section at the ends of All-Purpose (Linen/SuperSlide) shelving:

Use Shelf Stops to end a hanging section of Hang Rod Assembly on a shelf at the ends.

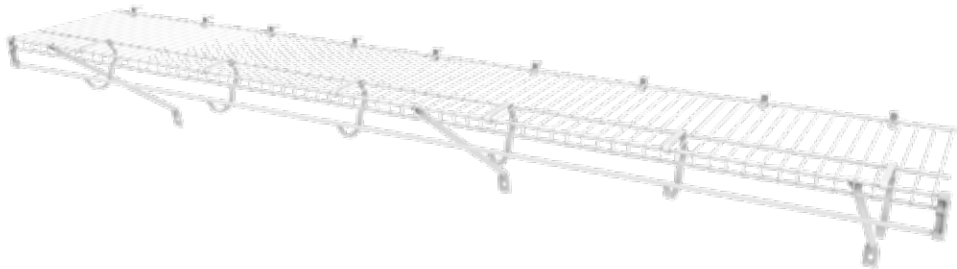

2

Installation Guidelines

Center Stack Installation

Center Stack - End Stop

Installation example - TS Pro Hang Rod ends on outside of center stack:

When shelf and hang rod terminate at the point on the outside of a support post, use a shelf stop to end hang rod and shelf 1" on outside of the support post.



Create Hanging Space inside Center Stack

Installation example - Using a TS Pro Hang Stop in combination with an All-purpose shelf and TS Pro Hang Rod:

Use a TS Pro Hang Stop 1" from the inside of a support post. Cut shelf so that 1" of overhang is represented on outside of each support post.

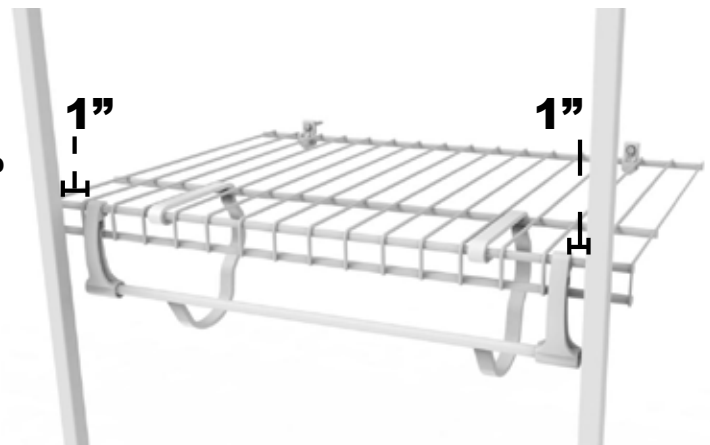

Hanging Space outside of Center Stack

Installation example - TS Pro Hang Rod ends on outside of center stack and shelf continues:

When shelf continues through center stack but hang rod ends at support post, use hang stop to end hang rod at 1" on the outside of support post

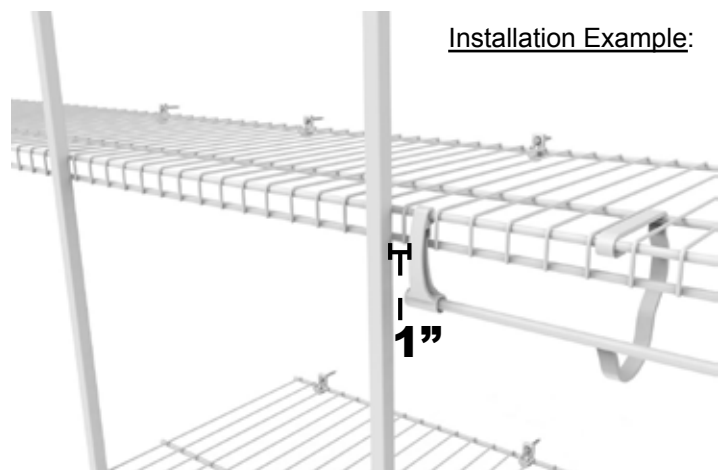

Installation Example:

3

Installation Guidelines

Corner & Rod Joiner Installations

Installation example - Using the TS Pro Corner Rounder, please note the following guidelines:

For any TS Pro Corner Rounder installation it is required to have at least 1" of TS Pro Hang Rod insertion into TS Pro Corner rounder tube

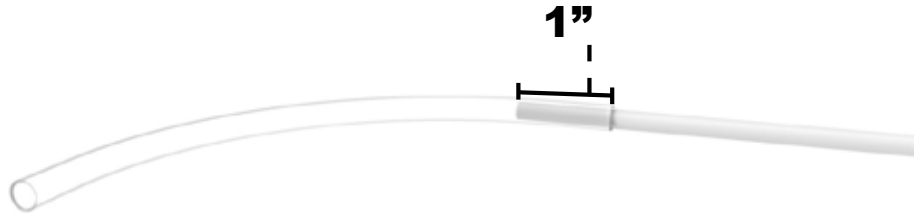

In any TS Pro Corner Rounder installation it is required to have no more than 3" of unsupported space from the edge of a Corner Rounder

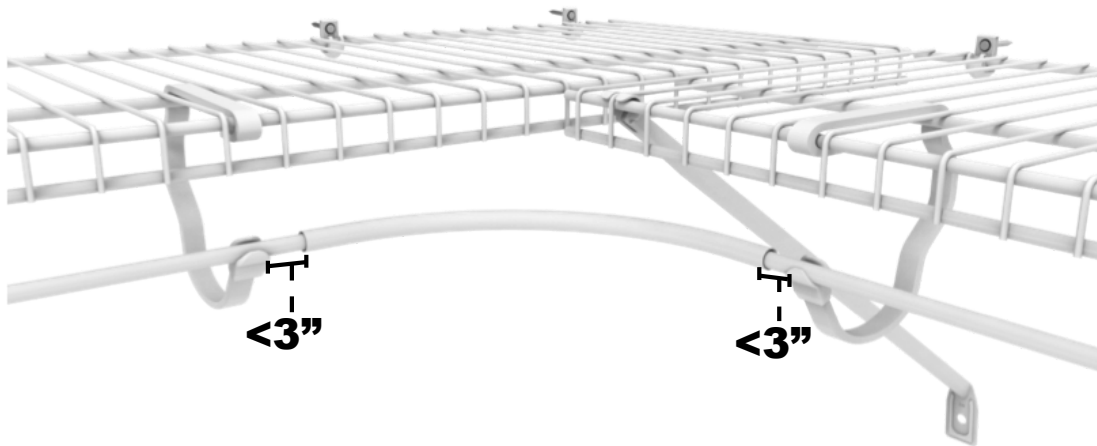

When installing the Rod Joiner, make sure that there is at least 1" of Hang Rod insertion into each side of the tube. The Rod Joiner should be positioned so that both ends of the tube rest against the side of each hook (as shown). Trimming of a Hang Rod section may need to occur if there is any overlap.

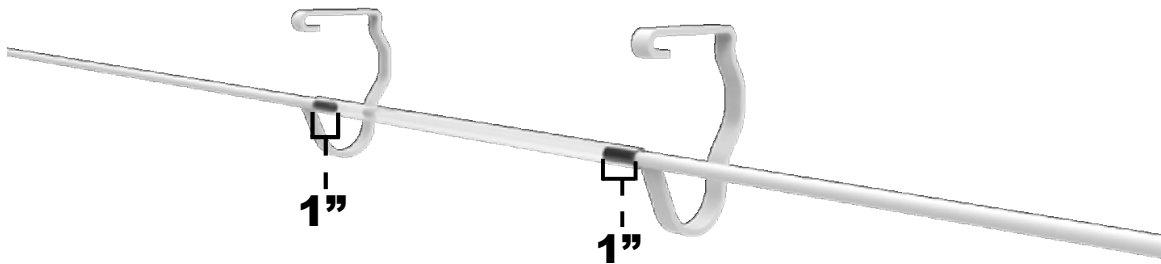

4

Installation Guidelines

End Bracket Installation

Installation example - Using LP SuperSlide End Bracket:

Install Hang Rod Assembly section on all shelves prior to shelf installation. Snap TS Pro Hang Rod Assembly into desired location onto the shelf. Place Hang Stop 1" away from edge of End Bracket.

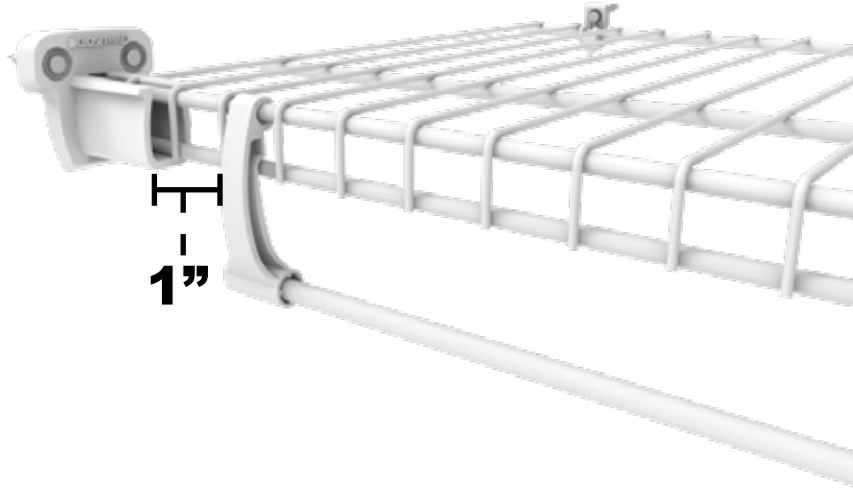

Installation example - Installing TS Pro Hang Rod with TotalSlide End Bracket:

Install Hang Rod Assembly section on to shelf prior to shelf installation. Snap TS Pro Hang Rod Assembly into desired location onto the shelf. The hang rod should be even with end of shelf. Rotate shelf and Hang Rod into bracket until secure fit.

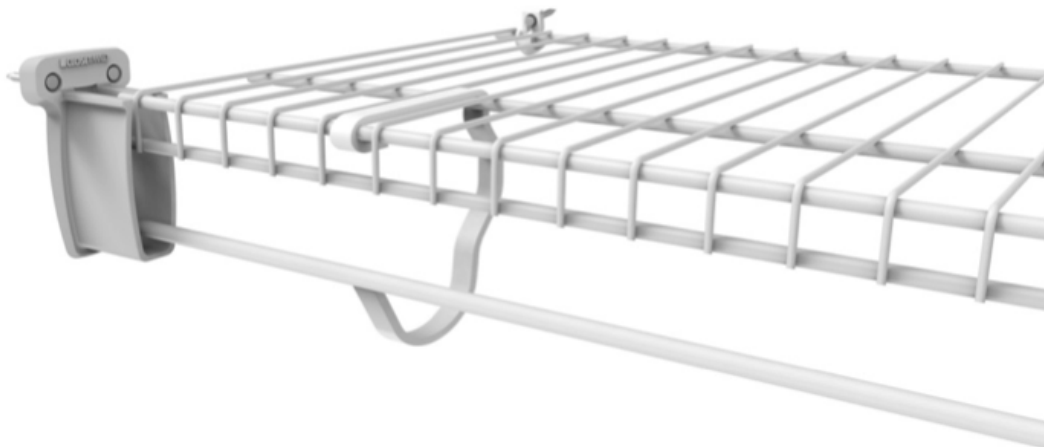



04-18069-00

TOTALSLIDE[®]PRO

Hang Rod Assembly Handling Instructions

The following instructions outline proper handling procedures for the TotalSlide[®] Pro Hang Rod Assembly. Please follow these handling instructions when moving or transporting sections:

 **IMPORTANT** 

The TotalSlide Pro Hang Rod Assembly was designed to be packed and unpacked in a sequential manner that allows them to nest and save space. It is important that you follow proper handling instructions. Make sure to stock, transport, and handle the sections in a nested manner that keeps the hooks tangle free.



1

Hang Rod Assembly Unpacking Instructions

- 1)** Position the TS Pro hang rod assembly on a table right side up.



- 2)** If any of the Hang Rod Assembly sections have shifted in the package, reposition the assembly so that the hooks are seated on the flat top.



- 3)** Unfold the side caps to make room to slide the Hang Rod Assembly sections out of the carton.



2

Hang Rod Assembly Unpacking Instructions

- 4)** Grip the bottom of the first Hang Rod Assembly in the locations as shown.



- 5)** **Only slide one section at a time.** Slide the first Hang Rod Assembly section to the left about 6" as shown.



- 6)** Rotate the Hang Rod Assembly forward (as shown) making sure that the back of the hooks clear the others.



- 7)** Once the back of the hooks have cleared the other Hang Rod Assembly's, lift it straight up and carry to the desired location



- 8)** Repeat the same procedure until the carton is empty



04-18069-00

TOTALSLIDE[®] PRO

Hang Rod Assembly & Hang Stop Installation Guidelines

The following scenarios show detailed installation guidelines when installing the TotalSlide[®] Pro Hang Rod Assembly on an All-Purpose (Linen/SuperSlide) Shelf. Please note the following:

Please follow proper Hang Rod Assembly handling instructions to ensure easy maneuvering of the sections. It is important to keep Hang Rod Assembly sections in alignment when moving, transporting, and installing.

It is suggested to install the Hang Rod Assembly on the shelf at the warehouse prior to transporting for installation. (See the TotalSlide Pro Installation Video)



1

Hang Rod Assembly Installation Guidelines

- 1)** Remove the All-Purpose (Linen/SuperSlide) shelf and transport it to a flat surface (preferably clean area)



- 2)** Place the shelf on its flat side with the lip facing towards you



- 3)** Move the Hang Rod Assembly section into position and place it on the flat surface (hook end down) with the opening facing towards you as shown



- 4)** Lift the Hang Rod Assembly section and position it between the deck wires on the shelf



- 5)** Position the Hang Rod Assembly so that the edge of the assembly rod aligns with the edge of the shelf (as shown)



2

Hang Rod Assembly Installation Guidelines

- 6)** Lift the shelf and Hang Rod Assembly section and begin to move the it under the cross wires and towards the front lip of the shelf



- 7)** Place the front of the Hang Rod Assembly hooks over the top rod on the front lip of the shelf



- 8)** Rotate the Hang Rod Assembly section upwards so that the back bottom of the hooks rest on the second cross rod



- 9)** Hang Rod Assembly should be attached and resting on the flat surface (as shown)



- 10)** Snap each hook into place by lifting the hook over the back cross rod



3

Hang Rod Assembly Installation Guidelines

- 11)** Measure the Hang Rod Assembly and shelf section per standard TotalSlide measuring practices



- 12)** Cut shelf and Hang Rod Assembly at desired locations



- 13)** Install shelf end caps where needed and prepare for transport to the site



4

Hang Rod Assembly Installation Guidelines (On -Site)

- 1)** Transport shelf into desired location for attachment of the Hang Rod Assembly



- 2)** Transport Hang Rod Assembly section into same desired location being careful to keep the shelf and Hang Rod Assembly separate from one another



- 3)** Keeping the Hang Rod Assembly section and shelf separate, begin to measure the section (if necessary)



- 4)** Measure the Hang Rod Assembly section and mark at proper dimension(s)



5

Hang Rod Assembly Installation Guidelines (On -Site)

- 5)** Cut the Hang Rod Assembly section(s) at proper dimension(s)

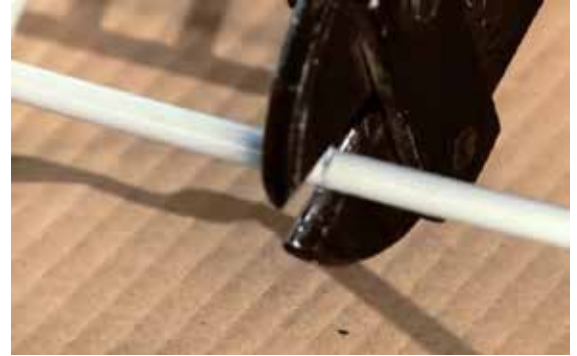

- 6)** Lift the Hang Rod Assembly section and shelf together. Position the Hang Rod Assembly section so that it is aligned with the end of the shelf and begin to place the section behind the second cross rod



- 7)** Rotate the Hang Rod Assembly so that the front of the hook captures the top rod of the front lip



6

Hang Rod Assembly Installation Guidelines (On -Site)

- 8)** Rotate the back end of the Hang Rod Assembly and place on flat surface

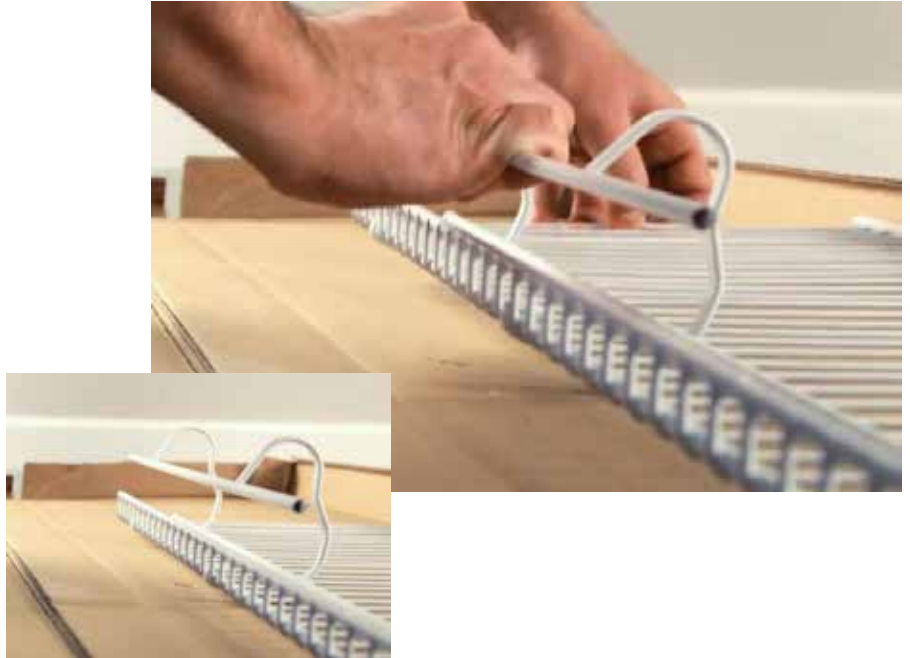

- 9)** Snap each hook into place by lifting the hook over the back cross rod and prepare to install

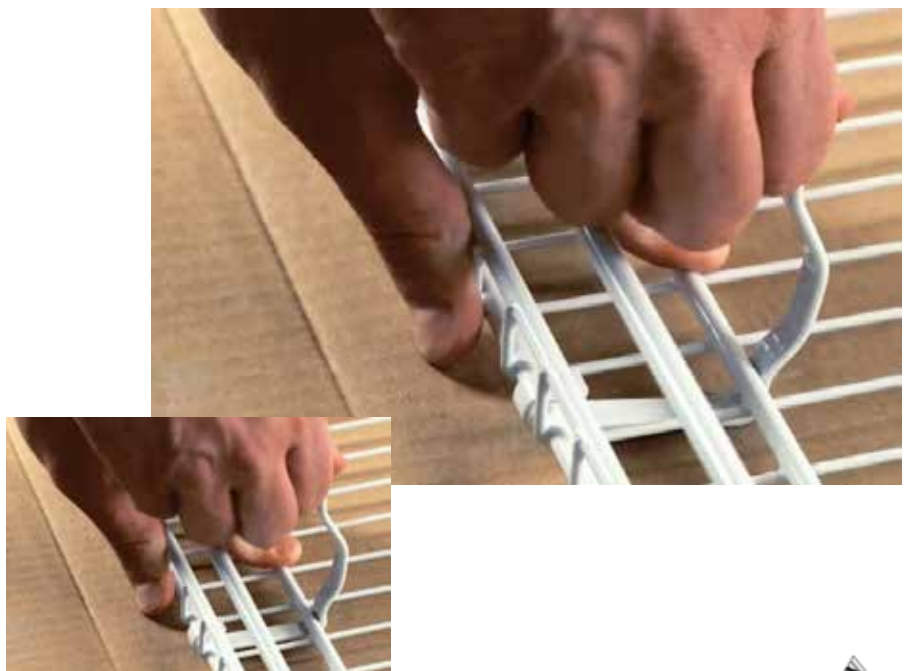

7

Hang Stop Installation Guidelines

- 1)** Slide the Hang Stop over the Hang Rod at the end of the rod.



- 2)** Rotate the top of the Hang Stop toward the top of the front lip of the shelf.



- 3)** Snap the top of the Hang Stop into onto the top of the front lip of the shelf.



- 4)** Hang Stop should look as pictured when installed.

